



**CAPACITOR
COMPETENCE**
since 1958

ENERGY CAPACITORS

ENERGY CAPACITORS · SNAP-IN TYPE

SSE ES SERIES

JIANGHAI EUROPE
Electronic Components GmbH



ENGINEERED SOLUTIONS

+++ PRELIMINARY DOCUMENT +++

v2019.1

<ul style="list-style-type: none"> · up to 1 500h at 65°C · up to 500 000 cycles · higher voltage · fast charge/discharge · EDLC 	
---	--

ITEM CHARACTERISTICS

Operating Temperature Range (°C)	-40 ~ +65 (-40 ~ +85 at 2,3V)
Rated Voltage (V)	3,0
Surge Voltage (V)	3,2
Capacitance Range (F)	100 ~ 400
Capacitance Tolerance (25°C)	+30/-10%

! The usage at lower temperatures than indicated may be possible. Please contact the Jianghai Europe sales office for approval.

Leakage Current	After 72 hours at 25°C application of rated voltage, leakage current is not more than specified in table.
-----------------	---

Self Discharge Voltage	After 72 hours storage at 25°C, 25-85% RH, and initial charging at U_r , the remaining voltage shall be $\geq 2,3V$
------------------------	---

Temperature Characteristics	The specification shall be met at upper category temperature of 65°C	Capacitance Change	$\pm 10\%$ of initial value
		ESR Change	less than initial value
	The specification shall be met at lower category temperature of -40°C	Capacitance Change	$\pm 30\%$ of initial value
		ESR Change	less than 200% of initial value

Load Life	The specification shall be met after rated voltage applied at 65°C for 1 500h	Capacitance Change	$\pm 30\%$ of initial value
		ESR Change	less than 200% of initial value

High Temperature Storage Time	The specification shall be met after storage at 65°C for 1 000h	Capacitance Change	$\pm 30\%$ of initial value
		ESR Change	less than 200% of initial value

Cycle Life	The specification shall be met after 500 000 cycles at 25°C; 1 cycle=charge-discharge from U_r to $\frac{1}{2}U_r$.	Capacitance Change	$\pm 30\%$ of initial value
		ESR Change	less than 200% of initial value

ENVIRONMENTAL
The products are RoHS, WEEE and REACH compliant. The detailed version please see separate "Environmental Certificates" document or www.jianghai-europe.com



SSE ES SERIES

ENERGY CAPACITORS · SNAP-IN TYPE

U_R	C_r	ESR_{DCMax}	ESR_{ACMax}	I_{leak}	I	I_5			SIZE	ORDER CODE
Rated Voltage (Surge Voltage) Code	Rated Capacitance 25°C	Equivalent Series Resistance 25°C	Equivalent Series Resistance 25°C 1kHz	Leakage Current 25°C (72h)	Rated Current 50°C U_R	Surge Current 30°C < 1sec	Energy Density	Power Density	DxL	◇◇ = pin style & length △△ = pin number
(V)	(F)	(mΩ)	(mΩ)	(μA)	(A)	(A)	(Wh/kg)	(kW/kg)	(mm)	Details: Page 4
3,0 (3,2) 3R0	100	12	8,0	300	3	83	5,95	8,93	22 x 45	SCCDES3R0107Q◇◇△△2245EE3
	200	10	6,0	700	7	115	6,94	6,25	30 x 50	SCCDES3R0207Q◇◇△△3050EE3
	350	3,5	3,0	1000	12	265	6,73	9,89	35 x 60	SCCDES3R0357Q◇◇△△3560EE3
	400	3,2	2,8	1000	13	272	7,35	10,34	35 x 60	SCCDES3R0407Q◇◇△△3560EE3

JIANGHAI EUROPE

Electronic Components GmbH



ENGINEERED SOLUTIONS

+++ PRELIMINARY DOCUMENT +++

Assistance needed? Please contact JIANGHAI Europe GmbH:

Tel.: +49 (0) 2151 652088-72 | E-Mail: info@jianghai-europe.com

3/12

v2019.1

ORDER CODE SNAP-IN TYPE

SC	C	D	PS	2R7	107	Q	T4	P2	2245	E	E3	JExxxx
Technology	Terminal Type	Energy-Capacitor Type	Series Code	Rated Voltage Code	Capacitance Code (in F)	Capacitance Tolerance Code	Pin Length	Pin	Dimension øD x h	Material Code Sleeve	for internal use	for Specials only
SC = Energy-Capacitor	Cell/Cylindric C	EDLC D	SSP PS SSE ES	2,7 2R7 3,0 3R0	60 606 100 107 120 127 150 157 200 207 220 227 350 357 400 407 470 477 1000 108	+30% / -10% Q +20% / -20% M	4,0mm T/L4 6,3mm T/L6 Lug SL	2 Pin P2 3 Pin P3 4 Pin P4	22x45 2245 25x50 2550 35x50 3550 35x60 3560	PET E PVC V	E3	

2 PIN TYPE: T6P2 / T4P2 STANDARD

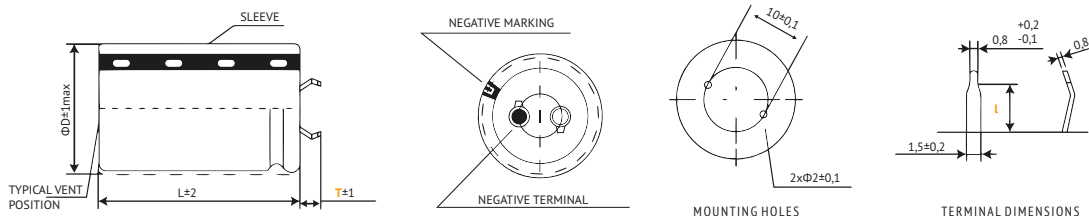

Standard Version: Self-Lock Terminal. Other terminal types and styles on request.
For diameter $\phi D \geq 45 \text{ mm}$ the safety vent is typically placed at the side of the housing.

! T4P2 preferred for diameter ≤ 30

Terminal	T6	T4 (preferred)
Pin Length T	6,3 mm	4,0 mm
Pin Detail L	3,5 mm	2,5 mm

in mm

3 PIN TYPE: T4P3

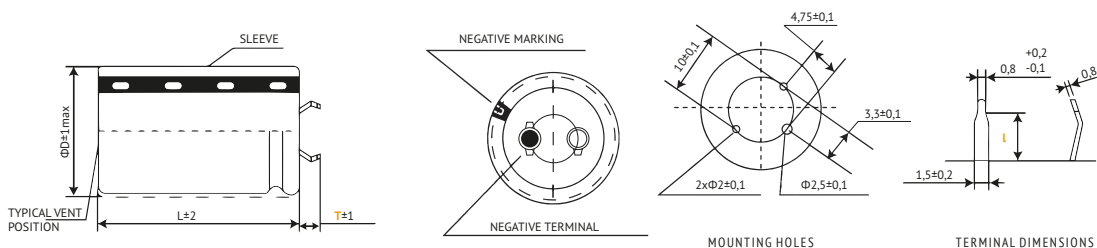

For diameter $\phi D \geq 45 \text{ mm}$ the safety vent is typically placed at the side of the housing.

Terminal	T6	T4
Pin Length T	-	4,0 mm
Pin Detail L	-	2,5 mm

in mm

4 PIN TYPE: T6P4/T4P4 STANDARD

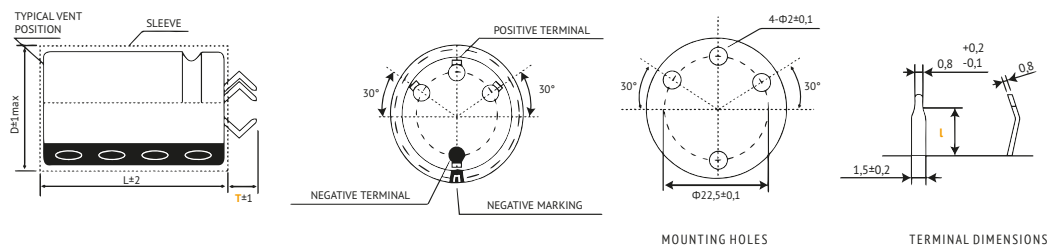

Standard Version: Non-Lock-Terminal. Other terminal types and styles on request.
For $\phi D \geq 30 \text{ mm}$ only.
For diameter $\phi D \geq 45 \text{ mm}$ the safety vent is typically placed at the side of the housing.

Terminal	T6 (preferred)	T4
Pin Length T	6,3 mm	4,0 mm
Pin Detail L	3,5 mm	2,5 mm

in mm

4 PIN TYPE: L6P4/L4P4 SELF-LOCK TERMINAL

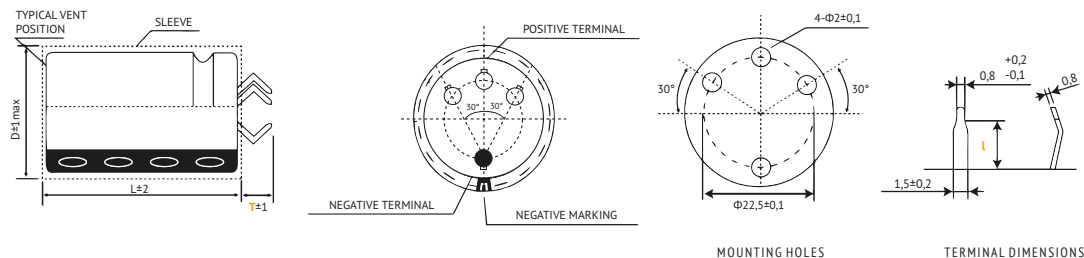

For $\phi D \geq 30$ mm only. Other terminal types and styles on request.
For diameter $\phi D \geq 45$ mm the safety vent is typically placed at the side of the housing.

Terminal	T6 (preferred)	T4
Pin Length T	6,3 mm	4,0 mm
Pin Detail L	3,5 mm	2,5 mm

in mm

LUG-TERMINAL: SLP2 STANDARD

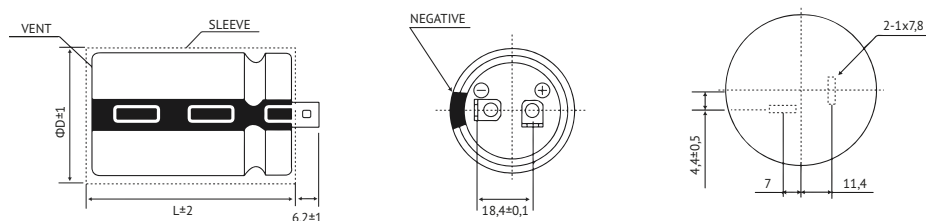

! SLP2 preferred for diameter ≥ 35 .

in mm

OTHER PIN STYLES ON REQUEST.

ABOUT ENERGY-C: TECHNICAL NOTES

Energy storage is an integral part of our modern world and one of the challenges of the future. The technology called „Energy Capacitors“ provides the energy storage in capacitors with new boost. The Ragone diagram (Fig. 1) shows the power density of various electrical energy storage devices versus their energy density.

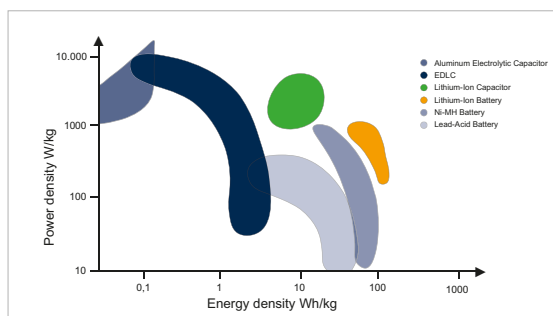

Fig. 1: Ragone diagram of various storage devices for electrical energy

The Energy-C concept basically uses two types of capacitors: the classic double-layer capacitor and the novel lithium-ion capacitor (Li-C).

» **EDLC**

The EDLC technology builds the basis of both types, which offers a relatively high energy density and a very high power density. The electrode material (activated carbon) is applied to an electrically contactable collector and forms the electrodes of the capacitors. A membrane („separator“), separates the electrodes from each other and thus protects them from short circuits. The separator must be permeable to the ions of the electrolyte. Those ions are the carriers of the electrical current in the EDLC (Fig. 2).

If a voltage is applied, the positively and negatively charged ions migrate to the electrodes. The ions collect at the phase boundaries of the solid electrodes to the liquid electrolyte and form the so-called double layer.

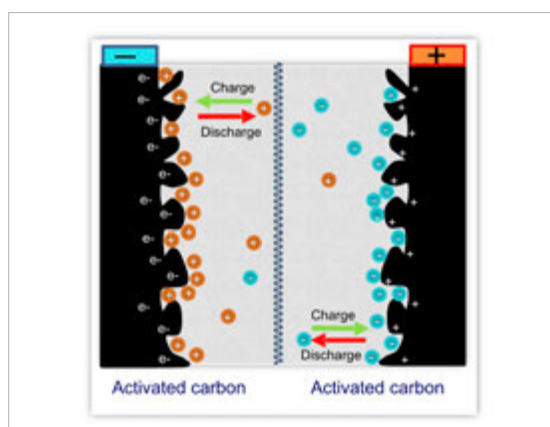

Fig. 2: Electrode structure of EDLC

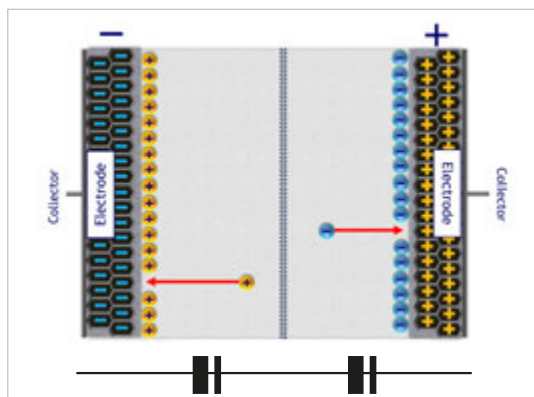

Fig. 3: Charged EDLC

The resulting electric field polarizes solvent molecules between the layers that separate the charges. The two electrodes connected in series work like a series connection of two capacitors (Fig. 3). Due to the very small distances of the double layer and the large surface, the capacitance of an EDLC is very high.

» **Li-C**

The modified design of the Lithium-Ion-Capacitors (Li-C) allows significantly increased energy density. A lithium-doped graphite electrode replaces one of the two symmetrical electrodes. As a consequence power densities are a little reduced compared to EDLC. Fig. (4) shows the inner construction of a Li-C: activated carbon like EDLC on one side and a doped graphite electrode on the other. As a result, Li-Cs approach the energy density close to batteries.

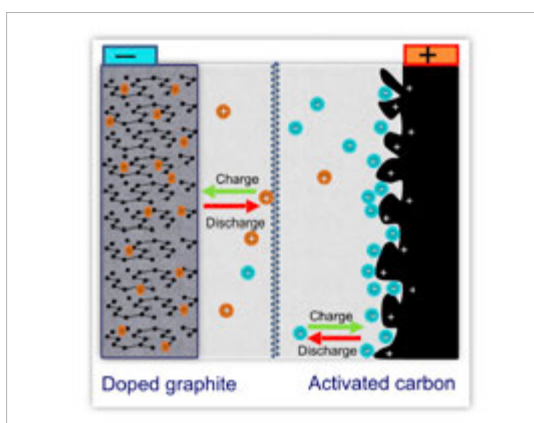

Fig. 4: Electrode structure of Li-C

>>

ABOUT ENERGY-C: TECHNICAL NOTES

» ADVANTAGES OF ENERGY-C

In terms of cycle stability and lifetime, the Energy-Cs are far ahead of the batteries. While lithium ion batteries offer merely about a thousand cycles, Li-Cs reach several hundreds of thousands of cycles. The special design and material combination of the lithium-ion capacitor ensures stability and charge retention even at high temperatures. While both batteries and Li-C remain stable at room temperature and discharge less than 5% over 2500 h, an EDLC already loses 30% of the charge after 2000h. At 60°C, the discharge rate increases significantly due to the accelerated chemical reactions between electrolyte and electrode material. The consequence of these chemical reactions is an increased leakage current and this leads to charge loss in batteries and EDLCs alike. While the leakage currents of the Li-C continue to be low, the lithium-ion battery now loses up to 30% of its charge after 2500 hours. When it comes to safety and reliability, the Li-C can also score: it is just as safe as an EDLC, due to the special process that firmly embeds the lithium ions in the molecular structure of the carbon structure („doping“). Unlike lithium batteries, no elaborate designs are needed to reduce the risk of thermal runaway with the known fire hazard. Due to the doping, there are neither metallic lithium nor lithium oxide in the capacitor. The doping method thus allows the capacitor to be always in a safe condition even with mechanical damage, high temperature, or heavy discharge. The production of a Li-C requires less than 3% of the lithium amount of a lithium battery of the same volume. In addition to the aspect of efficiency of resources, this results in a lower weight / smaller design as a nice side effect. The Ragone diagram (Fig. 1) shows that lithium-ion capacitors open up a new range for applications that previously were not covered, neither by batteries nor by any other type of capacitor. The Energy-C concept represents a new technology for existing and future applications of energy storage. The capacitors described here are already being mass produced by Jianghai and have proven their superior performance under real operating conditions in the field.

» TYPICAL APPLICATIONS

Traction and Railway, tram and electrified bus

Several functions could be realized by using Energy-C capacitors: reuse the power of braking, cost reductions by saving parts of the external electrification (overhead lines) and infrastructure. Fast charging during the stop and pick-up of passengers instead of a continuously connection to the grid are new concepts already in practice.

Elevators

Elevators often waste potential energy when the cabin goes down. Energy capacitors can be used to store the energy and use it for the next ascent. Such operation requires a high number of cycles combined with high charging- and discharging currents.

Automated Guided Vehicles

Automated Guided Vehicles automate and mobilize complete warehouses. Energy capacitors replacing batteries reduce the weight and volume significantly. The disadvantages of high maintenance costs and short service life of batteries is obsolete. Short stops during usage are used for charging the capacitors and allow a true 24-hour operation of all AGVs.

Recuperation of energy

Recuperation brakes in electric vehicles, in trains, in roller coasters or in machines like f.i. the fork of a forklift save energy and prolongs the life and usage time of the machine. There are thousands of applications with high numbers of charge-discharge cycles, which now can be used to increase the efficiency or allow a true energy saving. Additionally the life time of the batterie might be prolonged as the numbers of cycles for the battery are reduced.

Pitch Systems in Wind Turbines

Energy-Capacitors help to minimize costs due to their long service life and high cycle stability on this important safety unction.

Smartmeters & Energy Harvesting

Energy capacitors provide the energy for the short but intense transmission pulse. The Li-C, which has a much lower self-discharge than all other known technologies allow a true long-time handling even at high temperatures.

Backup systems

Energy-Cs allow extreme fast power in case of problems of the grid or power supplies, especially for larger power systems like hospitals, banks or industry. Such grid failures happen quite often in the range of milliseconds or seconds. The high number of cycles and the availability of large amounts of energy in a short time make energy capacitors the optimal technology choice.

HANDLING PRECAUTIONS

WARNING JIANGHAI is not liable for any extent of possible injuries or damages to persons or things, of any kind, caused by the improper application of and/or operating conditions harmful to Energy-Capacitors. Misapplications which may cause failures include, but are not limited to: operating current or peak current or voltage outside the specified range, operating voltage above surge voltage specified, temperature exposure outside of the specified operating temperature range. Examples of harmful operating conditions comprise, but are not limited to: unusual storage or transport temperatures, excessive and/or rapid changes of ambient temperature or humidity, heavy mechanical shock or vibration, corrosive and abrasive particles in the ambient (cooling) air, conducting dust in the ambient (cooling) air, oil or water vapor or corrosive substances, explosive gas or dust, operation under extremely high or low ambient pressure conditions (below or above sea level), superimposed radio frequency voltages, radioactivity. In case of doubt about the impact of operating conditions on capacitor performance, please contact JIANGHAI.

PERSONAL SAFETY Electrical or mechanical misapplication of Energy-Capacitors may be hazardous. Personal injury or property damage may result from explosion of a capacitor or from the expulsion of electrolyte due to mechanical disruption or the release of a safety vent of a capacitor. In case of injury or skin or eye exposure to electrolyte, immediately seek professional medical advice. Before using Energy-Capacitors in any application, please read these Handling Precautions, familiarizing thoroughly with the information contained herein. Please check before using any of our Energy-Capacitors if these components fulfill the requirements of your application and that warnings and instructions for use are followed.

WARRANTY The information contained in this datasheet does neither form part of any quotation nor of a contract, it is believed to be accurate, reliable and up to date. Quality data are based on the statistical evaluations of a large quantity of parts and do not constitute a guarantee in a legal sense. However, agreement on these specifications does mean that the customer may claim for replacement of individual defective capacitors within the terms of delivery. We cannot assume any liability beyond the replacement of defective components. This applies in particular to any further consequences of component failure. Furthermore it must be taken into consideration that the figures stated for lifetime, failure rates and outlier percentages refer to the average production status and are therefore to be understood as mean values (statistical expectations) for a large number of delivery lots of identical capacitors. These figures are based on application experience and data obtained from preceding tests under normal conditions, or – for purpose of accelerated aging – more severe conditions. JIANGHAI reserves the right to change these specifications without prior notice. Any application information given is advisory and does not form part of any specification. The products are not primarily designed for use in life supporting applications, devices or systems where malfunction of these products can reasonably be expected to result in personal injury. JIANGHAI customers using or selling these products for use in such applications without prior written consent of JIANGHAI do so at their own risk and agree fully to indemnify JIANGHAI for any damage resulting from such improper use or sale. This version of the datasheet supersedes all previous versions.

HANDLING GUIDELINES

- (1) Energy-Capacitors must not be used in AC and filtering circuits.
- (2) The actual operating voltage must not exceed the max. specified operating voltage and it must not fall below the min. specified operating voltage.
- (3) Please check the polarity before using. If operated under reverse polarity conditions, the capacitors will not only suffer from a shortened life time, but they may even swell, and electrolyte leakage or other malfunctions may result.
- (4) Environment: The operating temperature has an influence on the life time of the capacitors, and the maximum specified operating temperature must never be exceeded.
- (5) Current drain during discharge needs to be controlled to avoid a voltage drop below the min. voltage of the capacitor. The permissible current drain I_R is usually specified in the datasheet.
- (6) Capacitors in series connection: when capacitors are connected in series connection it must be ensured that the operating voltage of any single capacitor does not exceed to the limit of the max. and min. operating voltages. Systems for balancing and monitoring as well as modules are available on request. Please contact the JIANGHAI EUROPE Sales office for further Information.
- (7) Energy-Capacitors must not be short-circuited. Discharge below the minimum voltage will destroy the capacitor.

PRECAUTIONS

- (1) Prohibition of disassembly
Any attempt to disassemble the capacitor may result in short circuits to the capacitor, which may generate gas, and may cause electrolyte leakage, explosion or other problems.
- (2) Prohibition of dumping capacitors into fire to avoid potential risk of explosion.
- (3) Prohibition of immersing capacitors into water or seawater or any similar liquid.
- (4) Prohibition of using damaged capacitors: If any abnormal features of the capacitors are found (especially such as damages of the package, electrolyte leakage or others) the capacitor cannot be used anymore and must be stored away from open flames.
- (5) Prohibition of short-circuit or use outside the specified operating voltage range.
- (6) Prohibition of reverse voltage.

PRECAUTIONS FOR DEVICES USING ENERGY-CAPACITORS The operating conditions for modules, devices or application using Energy-Capacitors must follow the detailed operating condition of the individual cell.

OPERATING VOLTAGE (U_R) Energy-Capacitors are specified with a maximum operating voltage $U_{max} = U_R$ and a minimum operating voltage U_{min} . For a safe operation, these limits must be strictly adhered to.

SURGE VOLTAGE Maximum voltage, which may be applied to the capacitor for a short period of maximum 5 seconds within the complete lifetime.

EFFECT OF CURRENT FLOW Energy-Capacitor used with large currents will generate heat. Do not apply currents exceeding the maximum charge/discharge current. It may generate heat, deform, explode or lose electrolyte. Comply with the maximum specified charge/discharge currents in the datasheet.

>>



OPERATING CURRENT (I_R) The rated charge/discharge current is the current which can be used to charge and discharge the capacitor repeatedly without any pause. The current generates a temperature increase of 15 degrees and must be considered with existing outside temperature. The maximum temperature must not be exceeded.

MAX. CONSTANT CURRENT (I_{max}) The maximum constant charge/discharge current is specified with a minimum pause between charging cycles of 15 seconds. The current generates a temperature increase of 40 degrees and must be considered with existing outside temperature. The maximum temperature must not be exceeded.

SURGE CURRENT (I_S) The surge current is the maximum charge/discharge current and it is limited (see datasheet). The maximum temperature must not be exceeded.

SELF-DISCHARGE CURRENT (I_{SD}) The self-discharge current is specified after 3 months at ambient temperature of 25°C, relative humidity between 25% to 85% and without further voltage applied with t in seconds.

$$I_{SD} = \frac{C \cdot (U_R - U_3)}{t}$$

SELF-DISCHARGE VOLTAGE The self-discharge voltage is specified at ambient temperature 25±2°C. The following procedure must be followed to determine the self-discharge voltage drop:

- the capacitor is charged to rated voltage with constant current (operational current, see datasheet)
- the capacitor is kept at the rated voltage for 30 minutes
- open the circuit and store the capacitor for 72 hours at an ambient temperature of 25±2°C
- measure the self-discharge voltage between the capacitor terminals with a high ohmic voltmeter.

LEAKAGE CURRENT (I_{LEAK}) The leakage current is specified at ambient temperature 25±2°C. The following procedure must be followed to determine the leakage current:

- the capacitor is charged to rated voltage with constant current (operational current, see datasheet)
- the capacitor is kept at the rated voltage for 72 hours, during which the leakage current declines to a steady-state value
- measure the leakage current between the capacitor terminals for the characteristic leakage current

POLARITY The terminals of the product have a (positive or negative) polarity mark. Please check the polarity before using. Never apply any reverse voltage.

LIFETIME There are many different lifetime definitions known without any true standard definition. Take special care when capacitors of different manufacturers or technologies are compared. In the case of lifetime tests, please consider the rated operating voltage and rated operating temperature. Do not exceed the rated operating current.

LOAD LIFE Period of time, during which the technical parameters of all capacitors stay within the given limits. JIANGHAI does not allow for outliers.

HIGH TEMPERATURE STORAGE TIME Period of time, during which the technical parameters of all capacitors stay within the given limits. JIANGHAI does not allow for outliers.

CYCLE LIFE Number of charge and discharge cycles at ambient temperature 25°C during which the technical parameters of all capacitors stay within the given current limits and voltage range. JIANGHAI defines this without allowing for outliers.

TEMPERATURE CHARACTERISTICS The parameters of the capacitor are dependent of the temperature. Please check the datasheet or ask for assistance to define the temperature dependencies.

AC INTERNAL RESISTANCE (ESR_{AC}) Please note that the capacitor must not be connected to alternating voltage during regular operation. The only exemption is the determination of the ESR_{AC} , by a test procedure devised to determine the ESR without charging the component. At ambient temperature 25±2°C the capacitor is discharged to U_{min} with constant current I_R before testing. A sinusoidal alternating current signal with an amplitude of maximum 5 mA and a frequency of 1kHz is applied, then the decreasing alternating voltage at the capacitor is detected. The AC internal resistance of the capacitor is calculated according to the following formula:

$$ESR_{AC} = \frac{V_{AC}}{I_{AC}}$$

DC INTERNAL RESISTANCE (ESR_{DC}) At ambient temperature 25±2 °C, the DC internal resistance of a capacitor is evaluated by following these steps:

- the capacitor is charged to the rated voltage U_R with constant current I_R
- the capacitor is kept at the rated voltage U_R for 30 minutes
- the capacitor is discharged to the minimum operating voltage U_{min} with a constant current I_R , measure the voltage U_i after 30ms discharge
- repeat the steps for three times from (a) to (c)
- calculate the DC internal resistance of capacitor (R_{DC}) within the third cycle according to the following formula:

$$ESR_{DC} = \frac{(U_R - U_i)}{I}$$

VIBRATION AND MECHANICAL STRESS Capacitors are sensitive to vibration and mechanical forces applied on the leads. Do not use capacitors, which have been dropped onto a rigid surface.

INSULATION If any defect of the sleeve is visible, the component should not be used – the same holds for any kind of visible damage. A capacitor should be electrically isolated from the following parts: aluminum case, cathode lead wire, anode lead wire and circuit pattern, and auxiliary terminal of snap-in type. The sleeve of the capacitor is not an insulator and therefore the standard capacitor should not be used in a place where insulation function is needed. Please contact JIANGHAI if a higher grade of insulation is required.

ELECTROLYTE AND SEPARATOR PAPER Electrolyte and separator paper used in Energy-Capacitors may be flammable. Also electrolyte is electrically conductive. Therefore in case electrolyte gets in contact with PC board it may cause corrosion of circuit pattern or cause short circuit between patterns, and may lead to smoke generation or ignition in worst case.

CAUTION DURING USE OF CAPACITORS Do not touch the terminals of capacitors. Keep the capacitor free from conductive solution, such as acids, alkali and so on. Ensure that the operating environment of the equipment into which the capacitor has been built is within the specified conditions mentioned in the catalogue or specification sheets.

>>



SAFETY VENT (RADIAL AND SNAP-IN) The safety vent needs some free space to open properly. Allow free headroom of at least 2mm for diameter <16mm, more than 3mm for diameter 18-35mm. Do not place any wires or PCB tracks above the valve.

SOLDERING Please only use manual soldering. Don't use reflow soldering or wave-soldering or infrared heating or air heating. Heat shock will decrease the electric performance of capacitors or cause malfunction.

(1) Soldering temperature for radial and snap-in types should not exceed 260°C and soldering time not exceed 5s.

(2) Soldering temperature for pouch bag types should not exceed 420°C and soldering time not exceed 10s.

Take measure at prevent Energy-Capacitors becoming short-circuited during the soldering process.

GLUEING, CLEANING AND COATING Do not use fixing agents or cleaning substances containing halogens. Do not use coating and moulding components that completely seal the capacitors from the environment. Also never use solvents containing: Halogenated hydrocarbons, alkali, petroleum, trichloroethylene/-ethane, xylene, acetones, trichloro trifluoroethane, tetrachloroethylene, methylene chloride, chloroform, acetates, ketones, esters, chlorides and bromides.

MOUNTING Other devices, which are mounted near the capacitor, should not touch the capacitor. Heat transferred from other components to the capacitor may reduce the lifetime of the capacitor. Do never bend or twist the capacitor after soldering to avoid stress on the leads. Radial capacitors are not protected against mechanical forces on the leads. Forces on the pins might damage the capacitor. No printed circuit board tracks are allowed between the lead pads of the capacitor.

TRANSPORTATION

(1) Do not apply excessive vibration or shock when transporting the product.

(2) Prevent the packaging from being dropped during transportation or being stabbed by fork, lift forks etc. during freight handling.

(3) Package the product with individual terminals isolated to prevent short-circuits between them.

(4) Do not allow the product to get wet from, for example, rainwater, seawater, ice and snow, dew condensation, or freezing during transportation.

(5) Package the product in materials strong enough to prevent damage from stacking.

(6) Avoid fumigation and spraying insecticides (especially with bromides) in the import or export procedures which can cause corrosion. This applies also to the finished devices.

STORAGE CONDITIONS FOR LITHIUM-ION-CAPACITORS When storing the product for a long period of time, pack it in a way that stacking does not damage the product, taking care to preserve the isolation between individual terminals to prevent a short circuit between them.

(1) temperature 0°C to 35°C and relative humidity below 65%

(2) storage voltage 3,4V to 3,7V

(3) storage time above 1 year should be avoided

STORAGE CONDITIONS OF ELECTROLYTIC-DOUBLE-LAYER-CAPACITORS When storing the product for a long period of time, pack it in a way that stacking does not damage the product, taking care to preserve the isolation between individual terminals to prevent a short circuit between them.

(1) temperature 15°C to 35°C and relative humidity below 65%

(2) uncharged state (Voltage:0-0,3V)

(3) storage time above 4 year should be avoided

MAINTENANCE Periodical inspection should be carried out for the capacitor: visual inspection to check pressure relief open or leakage of electrolyte, electrical characteristic as self-discharge current and capacitance.

AIR TRANSPORTATION REGULATIONS Currently, Energy-Capacitors are not considered as dangerous goods in 2015IATA Regulations (status as of January 1st, 2019). However, as air transportation regulations may change, it is recommended that you should check the regulations each time you are transporting Lithium-Ion Capacitors and use an appropriate transportation method.

IN CASE OF EMERGENCY

(1) If the capacitor becomes deformed or damaged, stop using it and replace it immediately.

(2) If the cell starts leaking electrolyte or released gas and smoke, stop using it and replace it immediately. Keep away from open flames or sources of ignition.

Leaked electrolyte might cause short circuits on the PCB.

EMERGENCY ACTIONS When the pressure relief vent is open and some gas blows out from the capacitor, please turn the main switch of the equipment off or pull out the plug from the power outlet immediately. During safety vent operation, extremely hot gas (>100°C) may blow out of the capacitors. Do not stand close to the capacitors. In case of eye contact, rinse the open eye(s) with clean water immediately. In case of ingestion, gargle with water immediately, do not swallow. In the case of innervation please exposed to fresh air. Do not touch electrolyte but wash skin with soap and water in case of skin contact. In the case of an accident with electrolyte, please consult a doctor.

DISPOSAL Following the rules of WEEE, Energy-Capacitors must be collected separately as electronic waste.

Jianghai Europe Electronic Components
2019v1

ABOUT US: CAPACITORS FROM JIANGHAI

JIANGHAI EUROPE ELECTRONIC COMPONENTS GMBH IS THE EUROPEAN SALES ORGANIZATION OF NANTONG JIANGHAI CAPACITOR CO., LTD., NANTONG (CHINA). SINCE 2004, SALES, MARKETING, TECHNICAL SUPPORT, CUSTOMER SERVICE TEAM AND WAREHOUSE OF JIANGHAI EUROPE ELECTRONIC COMPONENTS GMBH ARE LOCATED IN KREFELD AND KEMPEN (GERMANY).

» Electrolytic Capacitors

Jianghai has grown since its foundation in 1958 to become the largest Chinese manufacturer of aluminum capacitors generating revenues of more than 450 million USD in 2018. While Jianghai started in the beginning with the production of specialty chemicals (e.g., electrolyte solutions), it entered the production of aluminum electrolytic capacitors already in 1970.

» Integration of Prematerial

More recently, Jianghai extended its production range by integrating high and low voltage anode foil etching and forming facilities. All factories are located in mainland China: the most important ones are in Nantong (north to Shanghai), in Inner Mongolia, and in XiAn area. Jianghai is well prepared for further expansion due to its successful entrance to the stock market in summer 2010.

» Film Capacitors

Jianghai's product range comprises aluminum electrolytic capacitors in screw terminal, snap-in and radial leaded styles. In 2012, the product portfolio was complemented by a range of power film capacitors. For this new business unit, Jianghai also follows the strategy of vertical integration and thus the production will extend from the preparation of the plastic film to the assembly of the finished goods. The product portfolio of DC-Link and Snubber capacitors has been enlarged in the year 2016 by AC-film capacitors. Highly automated production facilities ensure the efficient mass production of film capacitor modules. Driven by the thriving electric vehicle market in China, Jianghai has attained a leading position for the supply of these customer specific components.

» Polymer Capacitors

The year 2013 was marked by a major breakthrough in R&D for polymer aluminum electrolytic capacitors: the voltage proof for these ultra-low ESR products was pushed out to as much as 200V, enabling the utilization of these advanced capacitors in more applications, e.g. in white goods, industrial automation, telecom infrastructure, power supplies, and LED ballasts.

» Capacitor Competence Center

Global presence of experienced sales and technical marketing experts at offices in Europe, Asia and the Americas ensure the local support of our customers based on sound know-how in all project phases. In 2014 Jianghai Europe has established an additional service for its customers in Europe: Experts for capacitors are awaiting telephone calls or emails at the CCCenter as a kind of hotline for all kind of technical requests.

» Customized Products

Jianghai's particular strength as a volume manufacturer is to offer customized products. Jianghai focuses on the demanding professional industrial segment with many power electronics applications. Research and development in collaboration with several specialized university institutes as well as the access to all vital pre-materials enable Jianghai to create engineered, customized solutions to fit smoothly into a specific application.

Jianghai is continuously improving processes, thereby enhancing the quality of its products and services. The list of certificates awarded to Jianghai reflects its level of achievement. In the year 2013, the Jianghai Europe sales office has become certified according to ISO9001 and ISO14001.

» Contact

Jianghai Europe Electronic Components GmbH

Phone +49 (21 51) 65 20 88 - 0

Fax +49 (21 51) 65 20 88 - 88

E-Mail info@jianghai-europe.com

URL www.jianghai-europe.com