



**CAPACITOR
COMPETENCE**
since 1958

FILM CAPACITORS

FILM CAPACITORS · SNUBBER

CBB 166 IG SERIES

JIANGHAI EUROPE
Electronic Components GmbH



ENGINEERED SOLUTIONS

v2020.2

FEATURES

- Very low dissipation factor
- Highest peak pulse capability
- Design for Snubber Application
- Self-healing
- Soldering Terminal

OVERVIEW

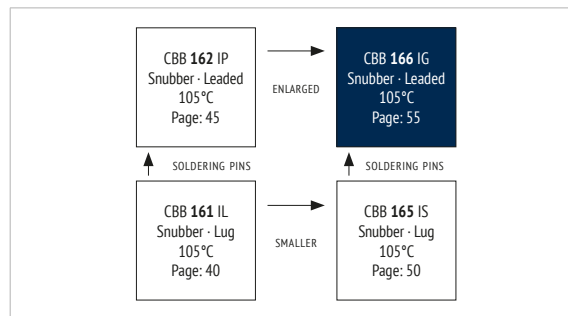

PRODUCT



APPLICATIONS

- High pulse and high frequency circuits
- IGBT applications

CHARACTERISTICS

ITEM	CHARACTERISTICS
Climatic Category	40/105/56 (IEC 61071)
Operating Temperature	-40 ~ +105 °C ($\Theta_{hotspot} \leq 105$ °C) $\Theta_{hotspot} = 85-105$ °C: See Voltage Derating Diagram
Storage Temperature	-40 ~ +105 °C
Rated Voltage U_{RDC}	850 ~ 2.000 V _{DC}
Capacitance Range	0,033 ~ 5,0 μ F
Capacitance Tolerance	± 10 % (K), ± 5 % (J)
Voltage between Terminals U_{TT}	$1,5 \cdot U_{RDC}$ (20 °C, 10s)
Voltage between Terminals & Case U_{TC}	$\geq 3.000 V_{AC}$ (20 °C, 50 Hz, 10s)
Capacitor Dissipation Factor $\tan \delta$	$\leq 1 \cdot 10^{-3}$ (20 °C, 1 kHz)
Dielectric Dissipation Factor $\tan \delta_0$	$\leq 2 \cdot 10^{-4}$ (20 °C, 1 kHz)
Insulation Resistance R_i °C	$\geq 30.000 M\Omega \cdot \mu$ F (20 °C, 100 V _{DC} , 1 min)
Max. Overvoltage	$1,1 \cdot U_{RDC}$ (30 % of time under load) $1,15 \cdot U_{RDC}$ (30 min. per day) $1,2 \cdot U_{RDC}$ (5 min. per day) $1,3 \cdot U_{RDC}$ (1 min. per day) $1,5 \cdot U_{RDC}$ (max. 30 ms, 100ms per day)
Life Time Expectancy	≥ 100.000 h, failure rate ≤ 100 FIT (70 °C)
Reference Standard	IEC 61071:2007

ENVIRONMENTAL

The products are RoHS, WEEE and REACh compliant.

The detailed version please see separate "Environmental Certificates" document or www.jianghai-europe.com

APPROVALS

UL94-V0:
Plastic & Compound Mass

LIFETIME

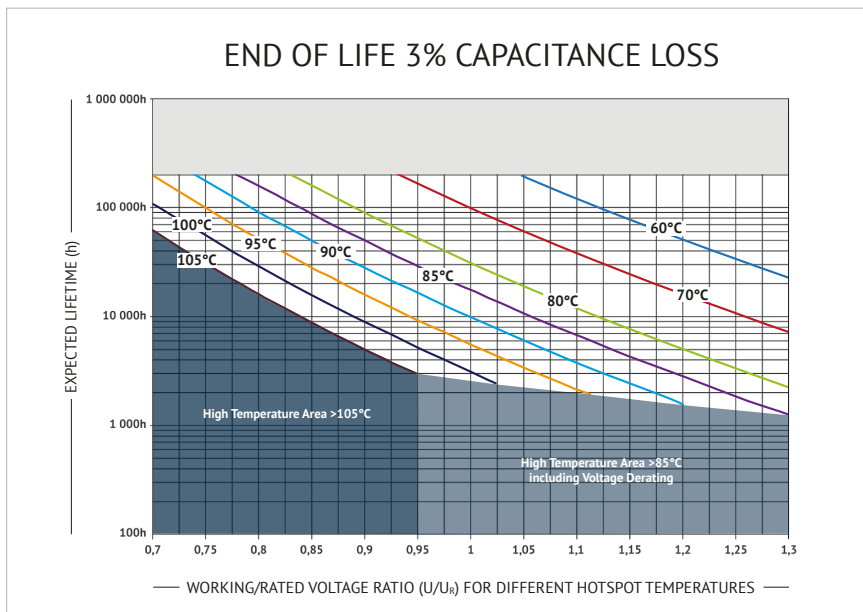

CURRENT DERATING

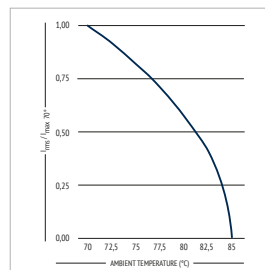

VOLTAGE DERATING

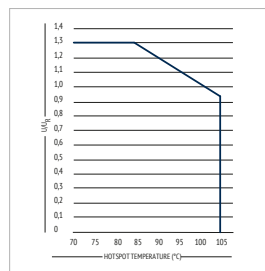

DIMENSIONS

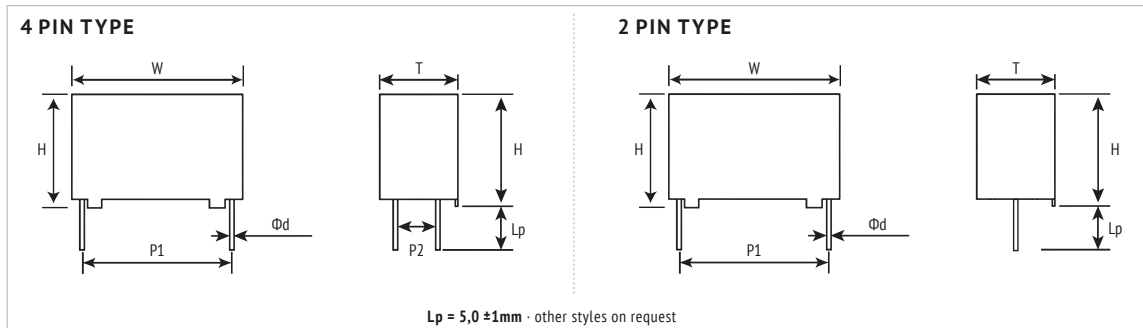

INTERNAL CONSTRUCTION

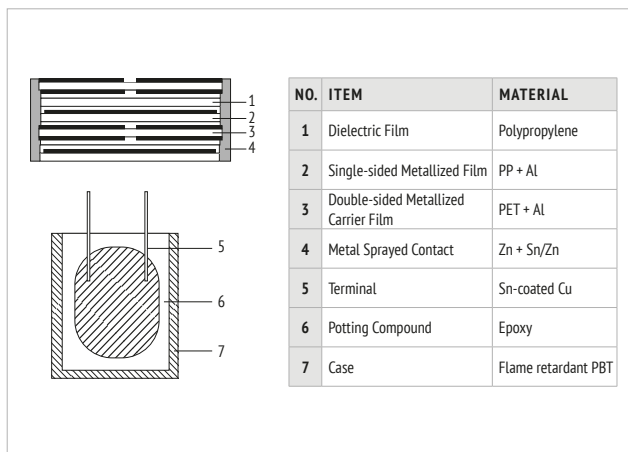

MARKING

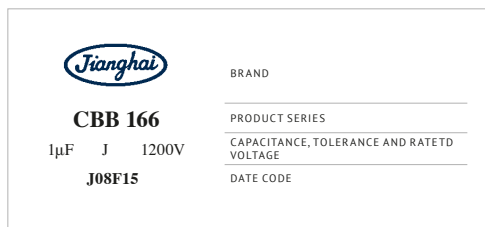

ORDER CODE

FC	S	3B	IG	105	K	A	FA	37	20	C	E 3
Capacitor type	Product shape	DC rated voltage code (V)	Series code	Capacitance Code (µF)	Capacitance tolerance	Pin Style (mm)	Dimension Code (mm) W x H x T ±1,0 ±1,0 ±1,0	Pitch P ₁ (mm)	Pitch P ₂ (mm)	Leadwire Diameter Ød	For internal use
Film Cap. = FC	Square box = S	850 K2 1000 3A 1200 3B 1600 3C 2000 3D	CBB 166 = IG	0,033 333 0,68 684 0,82 824 1,0 105 1,2 125 2,0 205 5,0 505	+5% J ±10% K	4 Pin Lp = 8mm K 4 Pin Lp = 5mm A 4 Pin Lp = 4,5mm L 4 Pin Lp = 4mm S 4 Pin Lp = 3,5mm J 2 Pin long leads (~ 20mm) C 2 Pin Lp = 5mm B 2 Pin Lp = 4,5mm T 2 Pin Lp = 4,0mm M 2 Pin Lp = 3,5mm U 2 Pin Lp = 3,2mm V	32 x 20 x 11 I4 32 x 22 x 13 I7 32 x 24,5 x 13 I8 32 x 28 x 14 IC 32 x 33 x 18 IF 32 x 37 x 22 II 42,5 x 37 x 28 F1 42,5 x 40 x 20 F2 42,5 x 32 x 19 F5 42,5 x 44 x 24 F9 42,5 x 45 x 30 FF 57,5 x 45 x 30 HH 57,5 x 50 x 35 HL	27,5 27 37,5 37 52,5 52	10,2 10 20,3 20 -	0,6 A 0,8 B 1,0 C 1,2 D 0,5 E	

RATINGS

U _R ≤85°C (V)	C _R (μF)	I _{max}		I ⁽¹⁾ (A)	R _s 20°C, 100kHz (mΩ)	R _{th} ⁽²⁾ (K/W)	dV/dt (V/μs)	L _s 20°C (nH)	W ±1,0 (mm)	H ±1,0 (mm)	T ±1,0 (mm)	P ₁ ±0,5 (mm)	P ₂ ±0,5 (mm)	ød ±0,05 (mm)	ORDER CODE	
		70°C, 100kHz (A)	60°C, 100kHz (A)													≤50°C, 100kHz (A)
850 V _{dc} 450 V _{ac} K2	0,15	8,0	11,0	12,0	195	14,5	10,8	1300	24	32	20	11	27,5	\	0,8	FCSK2IG154##142700BE3
	0,22	10,0	12,0	12,0	286	10,5	9,5	1300	24	32	22	13	27,5	\	0,8	FCSK2IG224##172700BE3
	0,33	12,0	12,0	12,0	429	7,6	7,8	1300	26	32	28	14	27,5	\	0,8	FCSK2IG334##1C2700BE3
	0,47	12,0	12,0	12,0	611	5,8	8,8	1300	26	32	33	18	27,5	\	0,8	FCSK2IG474##1F2700BE3
	0,68	12,0	12,0	12,0	884	4,6	8,5	1300	28	32	37	22	27,5	\	0,8	FCSK2IG684##1I2700BE3
	1	22,0	30,0	30,0	800	5,9	3,5	800	30	42,5	40	20	37,5	10,2	1	FCSK2IG105##F23710CE3
	2	29,0	30,0	30,0	1600	3,9	3,0	800	30	42,5	44	24	37,5	10,2	1	FCSK2IG205##F93710CE3
	3	29,0	36,0	36,0	1500	5	2,4	500	35	57,5	45	30	52,5	20,3	1,2	FCSK2IG305##HH5220DE3
	4	29,0	36,0	36,0	2000	4,2	2,8	500	35	57,5	45	30	52,5	20,3	1,2	FCSK2IG405##HH5220DE3
	5	29,0	36,0	36,0	2500	3,9	3,0	500	35	57,5	50	35	52,5	20,3	1,2	FCSK2IG505##HL5220DE3
1000 V _{dc} 500 V _{ac} 3A	0,15	8,0	11,0	12,0	210	14	11,2	1400	24	32	20	11	27,5	\	0,8	FCS3AIG154##142700BE3
	0,22	9,0	12,0	12,0	308	9,9	12,5	1400	24	32	22	13	27,5	\	0,8	FCS3AIG224##172700BE3
	0,33	10,0	12,0	12,0	462	7,2	13,9	1400	26	32	28	14	27,5	\	0,8	FCS3AIG334##1C2700BE3
	0,47	12,0	12,0	12,0	658	5,6	12,4	1400	26	32	33	18	27,5	\	0,8	FCS3AIG474##1F2700BE3
	0,68	12,0	12,0	12,0	612	4,4	11,6	900	28	32	37	22	27,5	\	0,8	FCS3AIG684##1I2700BE3
	1	16,0	22,0	27,0	900	5,5	7,1	900	30	42,5	40	20	37,5	10,2	1	FCS3AIG105##F23710CE3
	1,5	16,0	22,0	27,0	1350	4,2	9,3	900	30	42,5	37	28	37,5	10,2	1	FCS3AIG155##F13710CE3
	2	18,0	25,0	31,0	1800	3,7	8,3	900	30	42,5	45	30	37,5	20,3	1,2	FCS3AIG205##FF3720DE3
	2,2	18,0	25,0	31,0	1980	3,6	8,6	900	30	42,5	45	30	37,5	20,3	1,2	FCS3AIG225##FF2720DE3
	3	20,0	28,0	34,0	1650	4,7	5,3	550	35	57,5	45	30	52,5	20,3	1,2	FCS3AIG305##HH5220DE3
4	22,0	31,0	36,0	2200	4,2	4,9	550	35	57,5	50	35	52,5	20,3	1,2	FCS3AIG405##HL5220DE3	
4,7	24,0	33,0	36,0	2585	3,9	4,5	550	35	57,5	50	35	52,5	20,3	1,2	FCS3AIG475##HL5220DE3	
1200 V _{dc} 600 V _{ac} 3B	0,1	7,0	9,0	12,0	160	18,5	11,0	1600	24	32	20	11	27,5	\	0,8	FCS3BIG104##142700BE3
	0,15	10,0	12,0	12,0	240	12,8	7,8	1600	24	32	22	13	27,5	\	0,8	FCS3BIG154##172700BE3
	0,22	12,0	12,0	12,0	352	9,2	7,5	1600	26	32	28	14	27,5	\	0,8	FCS3BIG224##1C2700BE3
	0,33	12,0	12,0	12,0	528	6,7	7,6	1600	26	32	33	18	27,5	\	0,8	FCS3BIG334##1F2700BE3
	0,47	12,0	12,0	12,0	752	5,3	9,6	1600	28	32	37	22	27,5	\	0,8	FCS3BIG474##1I2700BE3
	0,68	16,0	22,0	27,0	680	6,6	5,9	1000	30	42,5	40	20	37,5	10,2	1	FCS3BIG684##F23710CE3
	1	18,0	25,0	30,0	1000	5,1	6,1	1000	30	42,5	40	20	37,5	10,2	1	FCS3BIG105##F23710CE3
	1,2	18,0	25,0	30,0	1200	4,4	7,0	1000	30	42,5	37	28	37,5	10,2	1	FCS3BIG125##F13710CE3
	2	20,0	28,0	34,0	1200	5,5	4,5	600	35	57,5	45	30	52,5	20,3	1,2	FCS3BIG205##HH5220DE3
	2,2	20,0	28,0	34,0	1320	5,2	4,8	600	35	57,5	45	30	52,5	20,3	1,2	FCS3BIG225##HH5220DE3
	2,5	22,0	31,0	36,0	1500	4,8	4,3	600	35	57,5	45	30	52,5	20,3	1,2	FCS3BIG255##HH5220DE3
	3	22,0	31,0	36,0	1800	4,5	4,6	600	35	57,5	50	35	52,5	20,3	1,2	FCS3BIG305##HL5220DE3
	3,3	24,0	33,0	36,0	1980	4,1	4,2	600	35	57,5	50	35	52,5	20,3	1,2	FCS3BIG335##HL5220DE3
1600 V _{dc} 650 V _{ac} 3C	0,1	8,0	11,0	12,0	190	13,5	11,6	1900	24	32	22	13	27,5	\	0,8	FCS3CIG104##172700BE3
	0,15	9,0	12,0	12,0	285	10,5	11,8	1900	24	32	24,5	13	27,5	\	0,8	FCS3CIG154##182700BE3
	0,18	10,0	12,0	12,0	342	9,5	10,5	1900	26	32	28	14	27,5	\	0,8	FCS3CIG184##1C2700BE3
	0,22	12,0	12,0	12,0	418	8	8,7	1900	26	32	33	18	27,5	\	0,8	FCS3CIG224##1F2700BE3
	0,27	12,0	12,0	12,0	513	7	7,3	1900	26	32	33	18	27,5	\	0,8	FCS3CIG274##1F2700BE3
	0,33	12,0	12,0	12,0	627	6,8	6,5	1900	28	32	37	22	27,5	\	0,8	FCS3CIG334##1I2700BE3
	0,39	12,0	12,0	12,0	741	6,5	6,8	1900	28	32	37	22	27,5	\	0,8	FCS3CIG394##1I2700BE3
	0,47	16,0	16,0	16,0	588	6	6,5	1250	30	42,5	32	19	37,5	\	1	FCS3CIG474##F53700CE3
	0,68	18,0	25,0	30,0	850	5	6,2	1250	30	42,5	40	20	37,5	10,2	1	FCS3CIG684##F23710CE3
	0,82	18,0	25,0	30,0	1025	5	6,2	1250	30	42,5	44	24	37,5	10,2	1	FCS3CIG824##F93710CE3
	1	19,0	26,0	32,0	1250	4,8	5,8	1250	30	42,5	45	30	37,5	20,3	1,2	FCS3CIG105##FF3720DE3
	1,2	19,0	26,0	32,0	1500	4,8	5,8	1250	30	42,5	45	30	37,5	20,3	1,2	FCS3CIG125##FF3720DE3
	1,5	20,0	28,0	34,0	1125	4,5	5,6	750	35	57,5	45	30	52,5	20,3	1,2	FCS3CIG155##HH5220DE3
	2	22,0	31,0	36,0	1500	4,2	4,9	750	35	57,5	50	35	52,5	20,3	1,2	FCS3CIG205##HL5220DE3
2000 V _{dc} 700 V _{ac} 3D	0,033	5,0	7,0	8,0	76	42,5	9,4	2300	24	32	20	11	27,5	\	0,8	FCS3DIG333##142700BE3
	0,047	6,0	8,0	10,0	108	30,5	9,1	2300	24	32	20	11	27,5	\	0,8	FCS3DIG473##142700BE3
	0,068	8,0	11,0	12,0	156	20,8	7,5	2300	24	32	22	13	27,5	\	0,8	FCS3DIG683##172700BE3
	0,1	10,0	12,0	12,0	230	15,2	6,6	2300	26	32	28	14	27,5	\	0,8	FCS3DIG104##1C2700BE3
	0,15	12,0	12,0	12,0	345	10,8	4,1	2300	26	32	33	18	27,5	\	0,8	FCS3DIG154##1F2700BE3
	0,22	12,0	12,0	12,0	506	7,8	4,4	2300	26	32	33	18	27,5	\	0,8	FCS3DIG224##1F2700BE3
	0,33	16,0	22,0	27,0	462	9,4	4,2	1400	30	42,5	40	20	37,5	10,2	1	FCS3DIG334##F23710CE3
	0,47	18,0	25,0	30,0	658	8,3	3,7	1400	30	42,5	44	24	37,5	10,2	1	FCS3DIG474##F93710CE3
	0,68	20,0	28,0	34,0	952	5,5	4,5	1400	30	42,5	45	30	37,5	20,3	1,2	FCS3DIG684##FF3720DE3
	1	22,0	31,0	36,0	850	7,3	2,8	850	35	57,5	45	30	52,5	20,3	1,2	FCS3DIG105##HH5220DE3
	1,5	24,0	33,0	36,0	1275	5,6	3,1	850	35	57,5	50	35	52,5	20,3	1,2	FCS3DIG155##HL5220DE3

(1) Maximum permissible peak current, (2) Thermal resistance from hotspot to ambient (free convection)



HANDLING PRECAUTIONS

WARRANTY The information contained in this datasheet does neither form part of any quotation nor of a contract, it is believed to be accurate, reliable and up to date. Quality data are based on the statistical evaluations of a large quantity of parts and do not constitute a guarantee in a legal sense. However, agreement on these specifications does mean that the customer may claim for replacement of individual defective capacitors within the terms of delivery. We cannot assume any liability beyond the replacement of defective components. This applies in particular to any further consequences of component failure. Furthermore it must be taken into consideration that the figures stated for lifetime and failure rates refer to the average production status and are therefore to be understood as mean values (statistical expectations) for a large number of delivery lots of identical capacitors. These figures are based on application experience and data obtained from preceding tests under normal conditions, or – for purpose of accelerated aging – more severe conditions. JIANGHAI reserves the right to change these specifications without prior notice. Any application information given is advisory and does not form part of any specification. The products are not primarily designed for use in life supporting applications, devices or systems where malfunction of these products can reasonably be expected to result in personal injury. JIANGHAI customers using or selling these products for use in such applications without prior written consent of JIANGHAI do so at their own risk and agree fully to indemnify JIANGHAI for any damage resulting from such improper use or sale. This version of the datasheet supersedes all previous versions.

NOMINAL CAPACITANCE C_N Nominal Capacitance is defined at 20°C and 50Hz (120Hz).

RATED VOLTAGE U_R, U_N Rated Voltage is the maximum operating peak voltage of either polarity but of a non-reversing type waveform (DC capacitors only), for which the capacitor has been designed, for continuous operation. The Rated Voltage is marked on the capacitor. See also Voltage Derating tables.

RATED AC VOLTAGE U_{RMS} Maximum RMS value for the sinusoidal alternating voltage.

OPERATING VOLTAGE The plastic film capacitor varies in the maximum applicable voltage depending on the applied voltage waveform, current waveform, frequency, ambient temperature (capacitor surface temperature), capacitance value, etc. Be sure to use capacitors within the specified values by checking the voltage waveform, current waveform, and frequency applied to them (In the application of high frequency, the permissible voltage varies with the type of the capacitor. Refer to the specification for details.)

NON-RECURRENT SURGE VOLTAGE U_S Peak voltage induced by a switching or any other disturbance of the system which is allowed for a limited number of times and for durations shorter than the basic period.

- Maximum duration: 50 ms / pulse

- Maximum number of occurrences: 1000 (during load)

MAXIMUM RATE OF VOLTAGE RISE dV/dt Maximum permissible repetitive rate of voltage rise of the operational voltage.

MAXIMUM CURRENT I_{MAX} Maximum Rms Current for continuous operation, see Current Derating tables.

MAXIMUM PEAK CURRENT \hat{I} Maximum permissible repetitive peak current which can occur during continuous operation. $\hat{I} = C_N \cdot (dV/dt)$

MAXIMUM SURGE CURRENT \hat{I}_S

- Maximum duration: 50 ms / pulse

- Maximum number of occurrences: 1000 (during load)

SERIES RESISTANCE R_S Effective ohmic resistance of the conducting elements of the capacitor.

EQUIVALENT SERIES RESISTANCE ESR The ESR represents all ohmic resistances: $ESR = \tan\delta / (\omega C) = R_S + \tan\delta / (\omega C)$

DIELECTRIC DISSIPATION FACTOR $\tan\delta$ Constant dissipation factor of the dielectric material.

LOSS FACTOR $\tan\delta$ The dissipation factor is the ratio between the reactive and effective power.

HOTSPOT TEMPERATURE $\Theta_{HOTSPOT}$ Temperature at the hottest position inside the capacitor. $\Theta_{HOTSPOT} = \Theta_{AMBIENT} + P_{LOSS} \cdot R_{TH}$

R_{TH} : thermal resistance, P_{LOSS} : Powerloss $P_{LOSS} = ESR \cdot I_{RMS}^2$, $\Theta_{AMBIENT}$ = ambient temperature

CHARGING AND DISCHARGING Because the charging and discharging current of capacitor is obtained by the product of voltage rise rate (dV/dt) and capacitance, low voltage charging and discharging may also cause deterioration of capacitor such as shorting and open due to sudden charging and discharging current. When charging and discharging, pass through a resistance of 20Ω/V to 1000Ω/V or more to limit the current. When connecting multiple film capacitors in parallel in withstand voltage test or life test, connect a resistance of 20Ω/V to 1000Ω/V or more in series to each capacitor. In addition, **capacitors must be discharged via a resistor before handling.** Because the capacitors do not have any discharge resistors built-in, there is a risk of residual voltages and electric energy contents that might be dangerous.

OPERATING CURRENT The pulse (or AC) current flowing through the capacitor is expressed as: $\hat{I} = C \cdot dV/dt$. Due to the fact that the dissipation factor of the capacitor is greater than zero, heat will be generated in any application where alternating currents or pulses occur. The resulting internal temperature rise may cause a severe deterioration of the capacitor's withstanding voltage, or may lead to a breakdown (even smoke or fire may result). Therefore, the safe use of capacitor must be within the rated voltage (or category voltage) and the permissible current ranges. The rated current must be considered by dividing into pulse current (peak current) and continuous current (rms current) depending on the break down mode, and when using, should make sure the both currents are within the permissible range.

TEMPERATURE RANGE AND ALTITUDE Use film capacitors only within the specified operating temperature range. The altitude and barometric pressure have an impact on the functionality of the capacitor. Max. Altitude: 2000m above sea level

EXPECTED LIFETIME The expected lifetime of the capacitor depends on the applied voltage and the hot spot temperature during operation. For capacitors applied in different situations, the obtainable average service lives are different. Please refer to the life time diagrams of each series.

FAILURE RATE λ (FAILURE IN TIME FIT) 1 FIT = 1/10⁹h (1 failure per 10⁹ components test hours), $\lambda = r/(nt)$

r = number of failure, n = test number, t = test time

INSULATION VOLTAGE U_i Rms value of AC voltage designed for the insulation between terminals of the capacitor to case or earth. The insulation voltage is equal to the rated voltage of the capacitor, divided by, unless otherwise specified.

INSULATION RESISTANCE R_i Ratio between applied DC Voltage and resulting leakage current after 1 minute of charge. It is defined in MΩ. Typically it is given as time constant $R_i \cdot C$ [μF] in seconds.

VOLTAGE BETWEEN TERMINALS U_{TT} Voltage between terminals.

VOLTAGE BETWEEN TERMINALS AND CASE U_{TC} Voltage between terminals and case.

BUZZING NOISE Any buzzing noise produced by a capacitor is caused by the vibration of the film due to the Coulomb force that is generated between the electrodes with opposite poles. It is of no harm to the capacitor.

SURFACE OVER TEMPERATURE $\Delta\Theta_{CASE}$ When current continuously flow through the capacitor, the temperature inside the capacitor will rise induced by dissipated heat. If the temperature exceeds the maximum allowed hot-spot temperature, it might cause a short circuit or fire. The limits described in the catalogue must not be exceeded and it's necessary to check the temperature on the capacitor's surface in operation.

FLAME RETARDATION Although flame retarding PU resin or plastic case material is used in the coating or encapsulation of plastic film capacitors, continuous exposure to high temperature ambient or fire will break the coating layer or plastic case of the capacitor, and may lead to melting and ignition of the capacitor element.

HUMID AMBIENT If used for a long time in a humid ambient, the capacitor might absorb humidity and oxidize the electrodes causing damage to the capacitor. In case of AC application, high humidity would increase the corona effect. This phenomenon causes a drop in capacitance and an increase of capacitor losses. Humidity needs to be avoided. If needed please inform Jianghai separately for technical adopted components.

STORAGE CONDITIONS 1) Capacitors must not be stored in corrosive atmospheres, particularly not when chlorides, sulfides, alkali, acids, lye, salts, organic solvents or similar substances are present. 2) It must not be stored in high temperature and/or high humidity environments. The following storage conditions must be kept (applicable only for storage in the original package): Temperature: ≤ 35 °C; Humidity: ≤ 80% RH, no dew allowed on the capacitor; Storage time: ≤ 24 months

MOUNTING Other devices, which are mounted near the capacitor, should not touch the capacitor. Additional heat coming from other components near the capacitor may reduce the lifetime of the capacitor. Do never attempt to bend or twist the capacitor after mounting and avoid any mechanical stress on the terminals. Never exceed the max. permissible torques when tightening the terminal screws or the mounting bolt's cap nuts.

CAUTION & WARNINGS Do not touch the terminals of capacitors. The energy stored in capacitors may be lethal. Ensure that the operating environment of the equipment into which the capacitor has been built, is within the specified conditions. Capacitors must not be used in corrosive atmospheres, particularly not when chlorides, sulfides, alkali, acid, lye, salts, organic solvents or similar substances are present. Electrical or mechanical misapplication may be hazardous. Personal injury or property damage may result from bursting of the capacitors or from expulsion of melted material.

Jianghai Europe GmbH, v3 0620

JIANGHAI EUROPE

Electronic Components GmbH



ENGINEERED SOLUTIONS

Customer specific adaptations needed? Please contact JIANGHAI Europe GmbH:
TELEFON: +49 (0) 2151 652088-0 | E-MAIL: INFO@JIANGHAI-EUROPE.COM

5/6
v2020.2

ABOUT US

Capacitors from Jianghai

JIANGHAI EUROPE ELECTRONIC COMPONENTS GMBH IS THE EUROPEAN SALES ORGANIZATION OF NANTONG JIANGHAI CAPACITOR CO., LTD., NANTONG (CHINA). SINCE 2004, SALES, MARKETING, TECHNICAL SUPPORT, CUSTOMER SERVICE TEAM AND WAREHOUSE OF JIANGHAI EUROPE ELECTRONIC COMPONENTS GMBH ARE LOCATED IN KREFELD AND KEMPEN (GERMANY).

» ELECTROLYTIC CAPACITORS

Jianghai has grown since its foundation in 1958 to become the largest Chinese manufacturer of aluminum capacitors generating revenues of more than 500 million USD in 2019. While Jianghai started in the beginning with the production of specialty chemicals (e.g., electrolyte solutions), it entered the production of aluminum electrolytic capacitors already in 1970.



» INTEGRATION OF PREMATERIAL

More recently, Jianghai extended its production range by integrating high and low voltage anode foil etching and forming facilities. All factories are located in mainland China: the most important ones are in Nantong (north to Shanghai), in Inner Mongolia, and in Xi'An area. Jianghai is well prepared for further expansion due to its successful entrance to the stock market in summer 2010.

» FILM CAPACITORS

Jianghai's product range comprises aluminum electrolytic capacitors in screw terminal, snap-in and radial leaded styles. In 2012, the product portfolio was complemented by a range of power film capacitors. For this new business unit, Jianghai also follows the strategy of vertical integration and thus the production will extend from the preparation of the plastic film to the assembly of the finished goods. The product portfolio of DC-Link and Snubber capacitors has been enlarged in the year 2016 by AC-film and X/Y capacitors. Highly automated production facilities ensure the efficient mass production of film capacitor modules. Driven by the thriving electric vehicle market in China, Jianghai has attained a leading position for the supply of these customer specific components.



» POLYMER CAPACITORS

The year 2013 was marked by a major breakthrough in R&D for polymer aluminum electrolytic capacitors: the voltage proof for these ultra-low ESR products was pushed out to as much as 200V, enabling the utilization of these advanced capacitors in more applications, e.g. in white goods, industrial automation, telecom infrastructure, power supplies, and LED ballasts.

» CAPACITOR COMPETENCE CENTER

Global presence of experienced sales and technical marketing experts at offices in Europe, Asia and the Americas ensure the local support of our customers based on sound know-how in all project phases. In 2014 Jianghai Europe has established an additional service for its customers in Europe: Experts for capacitors are awaiting telephone calls or emails at the CCCenter as a kind of hotline for all kind of technical requests.



» CUSTOMIZED PRODUCTS

Jianghai's particular strength as a volume manufacturer is to offer customized products. Jianghai focuses on the demanding professional industrial segment with many power electronics applications. Research and development in collaboration with several specialized university institutes as well as the access to all vital pre-materials enable Jianghai to create engineered, customized solutions to fit smoothly into a specific application.

Jianghai is continuously improving processes, thereby enhancing the quality of its products and services. The list of certificates awarded to Jianghai reflects its level of achievement. In the year 2013, the Jianghai Europe sales office has become certified according to ISO9001 and ISO14001.

» CONTACT

Jianghai Europe Electronic Components GmbH
Phone +49 (21 51) 65 20 88 – 0
Fax +49 (21 51) 65 20 88 – 88
E-Mail info@jianghai-europe.com

JIANGHAI EUROPE

Electronic Components GmbH



ENGINEERED SOLUTIONS

Customer specific adaptations needed? Please contact JIANGHAI Europe GmbH:
TELEFON: +49 (0) 2151 652088-0 | E-MAIL: INFO@JIANGHAI-EUROPE.COM

6/6
v2020.2